

*Focus*

*Virtual Studio*

*Sound Configure*

**User's Guide**

Revision as of August 26, 2010

VS 1.63

Copyright © SoftLab-NSK Ltd.

# Table of Contents

<b>1</b>	<b>INTRODUCTION .....</b>	<b>3</b>
<b>2</b>	<b>MAIN WINDOW .....</b>	<b>4</b>
<b>3</b>	<b>CONTROLLING THE INPUT SIGNALS.....</b>	<b>6</b>
<b>3.1</b>	<b>Mixing the Input Signals .....</b>	<b>7</b>
<b>3.2</b>	<b>Working with Stereo .....</b>	<b>9</b>
<b>4</b>	<b>CONTROLLING THE PC AUDIO DEVICES .....</b>	<b>11</b>
<b>5</b>	<b>CONTROLLING THE OUTPUT SIGNALS.....</b>	<b>12</b>
<b>6</b>	<b>SETTING APPLICATION PARAMETERS .....</b>	<b>13</b>

# 1 Introduction

The *Sound Configure* application is released as an independent **FDSoundControl.exe** program and can be run separately from the *Focus* virtual studio. Within the studio (*HotActionsLite* application), the

*Sound Configure* application can be launched with the  button. Or the required dialog box can be opened from the **Tools** menu.

When creating a multimedia product, it is often needed to gather sound signals from various sources into one or several signals. For example, to join music and vocal, overlay a sound with some additional sounds from other sources, etc. The audio-control engineer has a wide range of tasks. The *Sound Configure* application allows you to accomplish one of them: mixing several audio signals from various sources in real time. Besides, it is possible to set a delay time for the input audio signals in milliseconds.

The *Focus* hardware/software package provides 6 mono inputs and 6 mono outputs. The inputs and outputs are grouped in stereo pairs (Figure 1). It is possible to set a delay time, the input volume level, and the output balance independently for each of the inputs, as well as to direct sound from an input to any of the stereo outputs. It is possible to set volume and balance for each output stereo pair.

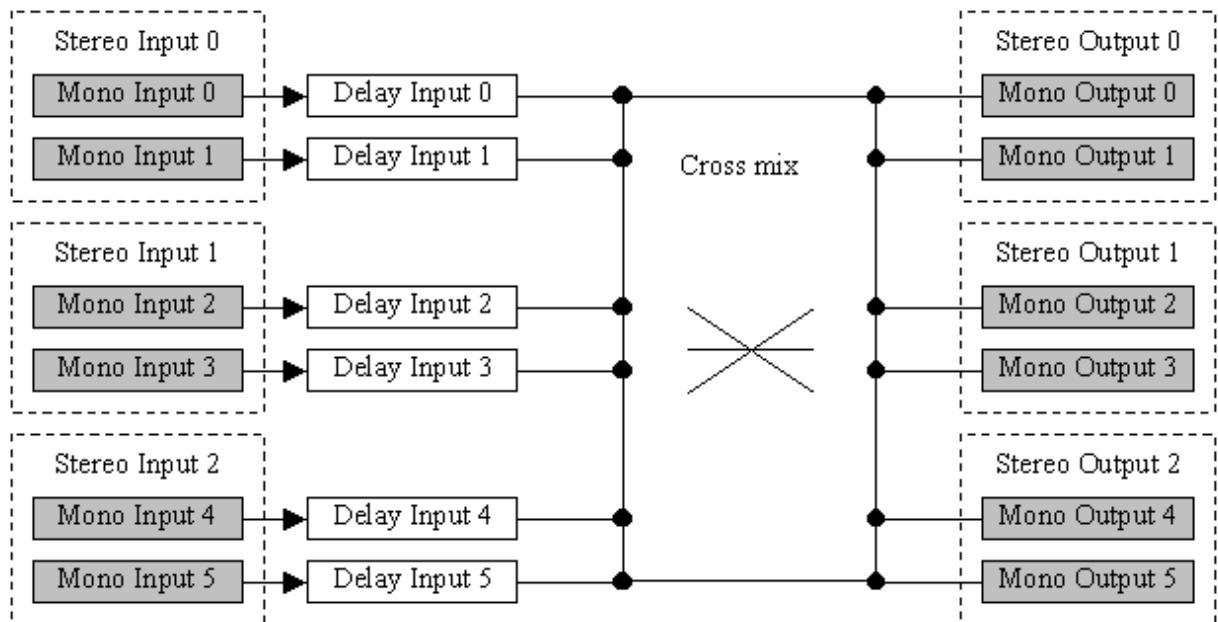

Figure 1. Sound mixing diagram.

The *Focus* audio subsystem has a typical audio mixer that can be controlled with a standard volume regulator. The mixer allows you to control the volume of the following system audio devices:

- a digital compact disc playback (**CD Player** is accessible if allowed in the system);
- a standard **Wave** device;
- a software synthesizer MIDI (**SW Synth**).

This User's Guide is intended for a user working with *Virtual Studio* and discusses the *Sound Configure* application interface.

## 2 Main Window

Launch the *Sound Configure* application. The *Sound Configure* main window opens (Figure 2). Its design imitates a mixer console used in conventional audio recording studios.

The application main window contains 4 areas:

- controls of the input signals (see Section 3);
- controls of the standard PC audio devices (see Section 3);
- controls of the output signals (see Section 5);
- the application settings (see Section 5).

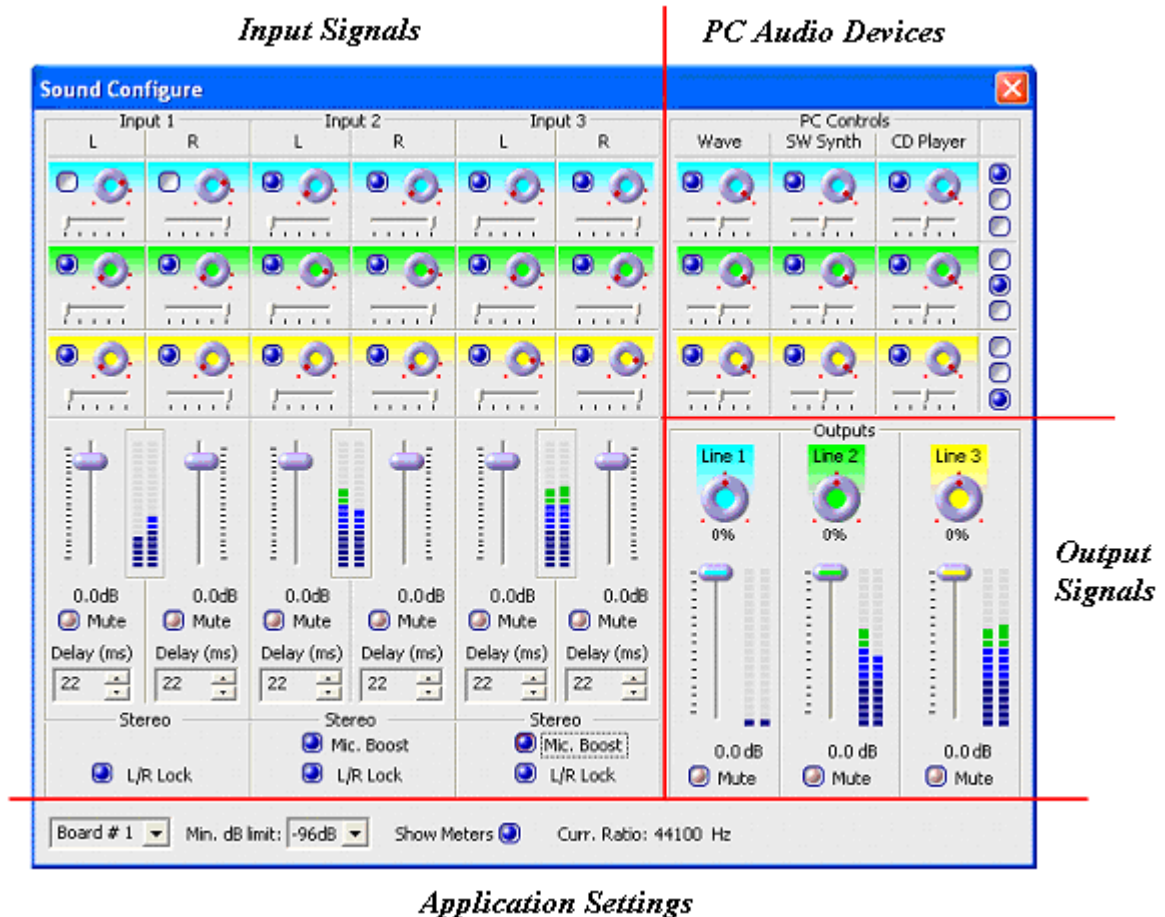

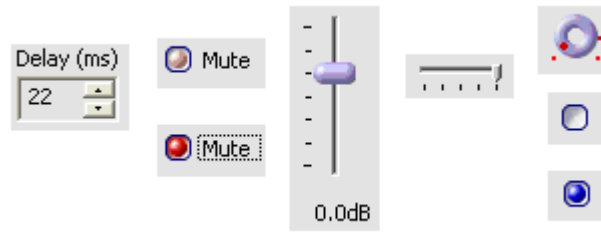

Figure 2. The *Sound Configure* main window.

The input and output signals are conditionally divided into pairs and designated **Input 1**, **Input 2**, **Input 3** and **Output 1**, **Output 2**, **Output 3** accordingly. Within each pair, the signals are distinguished as left and right (**L** and **R**). The input and output signal areas contain the following control elements (Figure 3):

- The **Delay (ms)** edit box is used to set a delay in milliseconds.
- The **Mute** check box is used to switch the signal on/off.
- The vertical slider is moved upwards/downwards to change the volume.
- The horizontal slider is used to set a sound balance (the **Input...** areas only).
- The output routing knobs with the check boxes (in the **Input...** areas) and the balance routing knobs (in the **Outputs** area). To change the volume level, move the mouse in a circle with the left button pressed. The farther the mouse cursor from the center of the routing knob, the finer adjustment. When pointing the cursor at a routing knob, the cursor changes its form to  (left mouse button released). When working with a routing knob, the cursor has the  form (left mouse button pressed).



**Figure 3. The controls.**

The control elements of the PC standard sound devices are located in the upper right part of the main window. The nine check boxes are used to redirect the sound streams from the system devices to any of the outputs (see Section 4).

The application settings area is located in the bottom part of the main window. All the areas are discussed in more detail below.

### 3 Controlling the Input Signals

The control elements of the inputs are located in the upper left part of the *Sound Configure* application main window. The **Input 1**, **Input 2**, and **Input 3** areas and the control zones within the areas are shown in Figure 4:

- mixing zone of the input signals (Section 3.1);
- control zone of the input signals;
- the stereo mode switching on/off and signal amplification zone (Section 3.2).

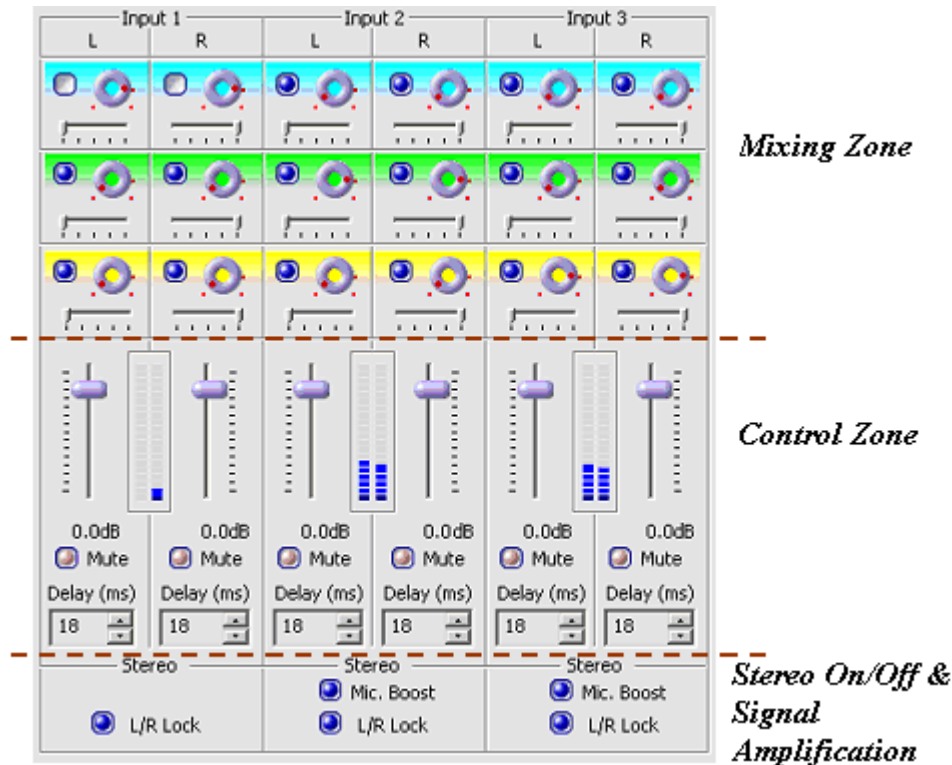

Figure 4. Control zones of the input signals.

Each of the six mono inputs has the following controls located in the middle part of the input signal areas (Figure 4).

- The **Delay (ms)** edit box (Figure 5). The delay time is measured in milliseconds, the upper limit being 999 ms (up to 1 second). There is a bottom hardware delay limit to transfer external signals to the output channels. It is impossible to set a delay under this level. The delay value can be changed using the keyboard by entering a value directly in the delay edit box or using the mouse by pressing the buttons located in the right part of the **Delay (ms)** edit box.

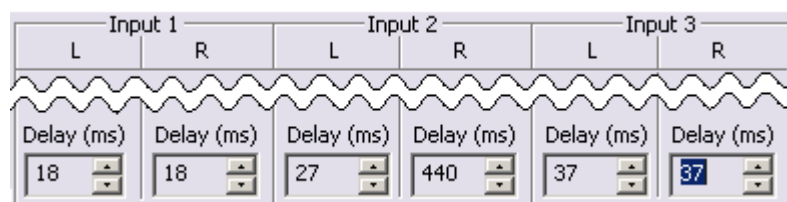

Figure 5. Using a delay for the input signals.

- The **Mute** check box for switching a signal on/off. Any input signal can be switched off the mixing process by checking the corresponding **Mute** check box (Figure 6). The signal can be included back to the mixing process by unchecking the check box.

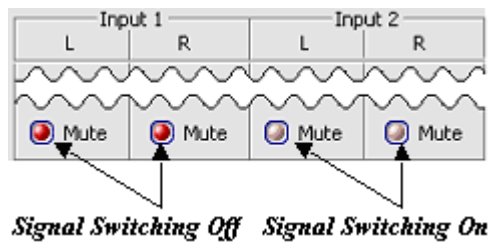



Figure 6. Enabling/disabling input signals.

- The vertical volume slider. To change the volume level, move it upwards/downwards. The available range of the volume level change is from +12 dB up to -96 dB, which means a change of the signal volume level from a 4-fold increase to practically complete switching off (Figure 7). To change the volume level, move the slider with the mouse. The current volume level is indicated under the volume sliders.

 This application has the ability to change the zoom of the volume level scale for better usability of the volume slider, e.g., when working with loud signals (see Section 6).

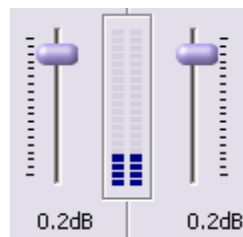



Figure 7. The vertical volume sliders and indicators of the input level.

- The three horizontal balance sliders with output routing knobs and check boxes. If the top check box is on, the sound from the selected input is directed to stereo output 1 with the output volume level set with the output routing knob on the right of the check box. The middle (second from above) check box and the output routing knob operate the sound output to stereo output 2 etc.

To change the volume level, move the mouse in a circle with the left button pressed. The farther the mouse cursor is from the center of the routing knob, the finer adjustment. When pointing the cursor at a routing knob, the cursor changes its form to  (left mouse button released). When working with a routing knob, the cursor has the  form (left mouse button pressed).

The volume level indicator of the signal from the corresponding source is located between the vertical volume sliders for the left and right signals (Figure 8). It is possible to estimate the input signal power (relative to a standard audio range) by the color palette of the signal power indicator: from a faint signal up to a critical level, when a distortion of the signal is possible.

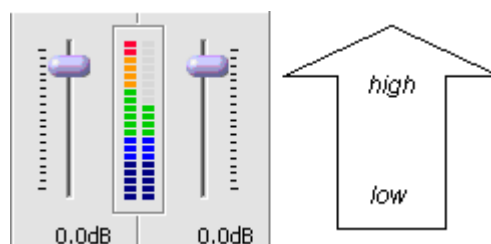

Figure 8. Colors of the signal power indicator.

The **Show meters** check box in the application settings area in the bottom part of the main window (see Section 6) is used to switch on the volume level indicators.

### 3.1 Mixing the Input Signals

The required control elements for mixing signals are located in the upper part of the input signal areas. The *Sound Configure* application allows you to determine the output volume level for each input signal.

Each of the input signals can be transferred to any of the three output lines. For that, switch the check box corresponding to the chosen output channel. The color palette allows you to determine the number of the output channel to which the signal is transferred. The output channel background color is identical to the input settings background color (Figure 9).

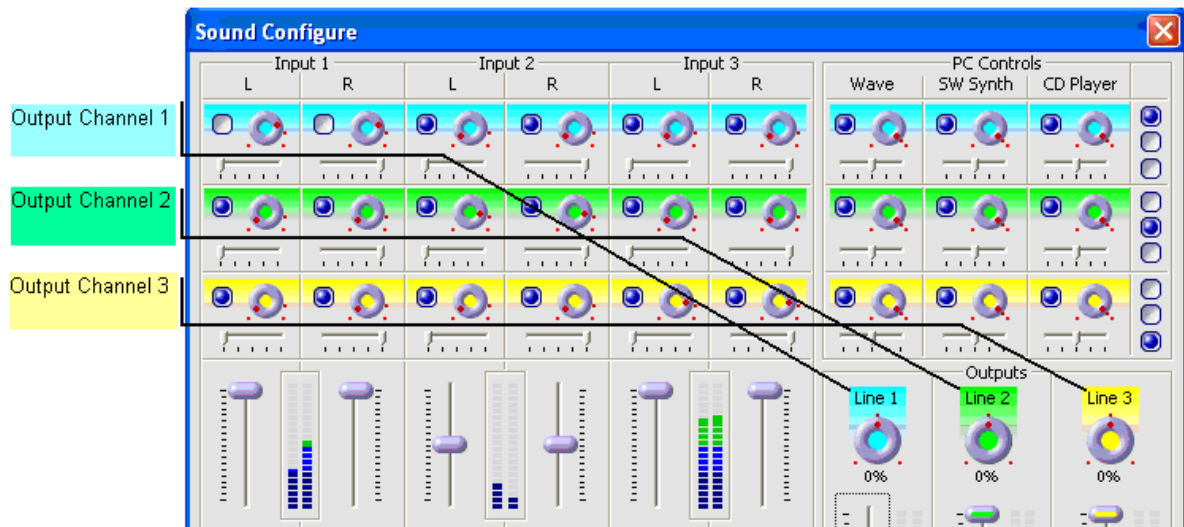

**Figure 9. Visual determination of the output channel.**

When pointing the cursor at the check box, a tool tip with the information of the input signal line number and the corresponding output line number appears (Figure 10).



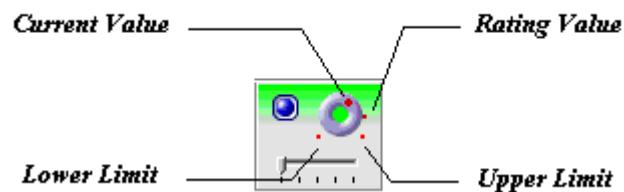

**Figure 10. Transfer of the second right input signal to the second output line..**

The volume level control of the input-to-output transfer is performed with the volume routing knob. The available range of the volume level change is from +12 dB to -96 dB (from 4-fold increase to practically complete switching off). The points at the bottom of the volume routing knob designate the lower and upper limit of the volume level change. The point between them (above them) designates a zero (normal) volume level – absence of a change of the volume level (Figure 11).

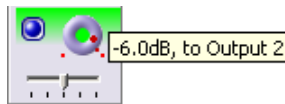

**Figure 11. Changing the volume level of an input signal when transferring to the output channel.**

To get the information of the external input signal numerical value on the current output, bring the cursor to the routing knob and hold it for a couple of seconds.

To change the volume level, move the mouse in a circle with the left button pressed. The farther the mouse cursor is from the center of the routing knob, the finer adjustment. When pointing the cursor at a routing knob, the cursor changes its form to  (left mouse button released). When working with a routing knob, the cursor has the  form (left mouse button pressed).

When the volume is being changed, a tool tip with the volume numerical value and the output channel number is displayed (Figure 12).



**Figure 12. A tool tip about the input signal volume level when transferring to the output channel.**

When changing the zoom of the volume level scale, the sensitivity of the scale upper part adjustment is changed. (see Section 6).

 *This application has the ability to change the zoom of the volume level scale for better usability of the volume slider, e.g., when working with loud signals (see Section 6).*

When transferring an input signal to an output channel, it is possible to adjust balancing between the right and left output channels using the balance slider (Figure 13, Figure 18). For that, switch on the chosen output channel. It can be determined by the background color palette, the output channel background color being identical to the input signal settings background color (Figure 9).

Besides, when pointing the cursor at the check box, a tool tip with the information of the input signal line number and the corresponding output line number appears (Figure 10).

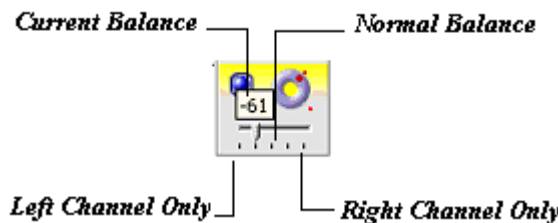

**Figure 13. A tool tip about balancing between the left and right output channels**

### 3.2 Working with Stereo

It is possible to supply a stereo signal to an external input of *Focus*. It is desirable that the source of the stereo pair be connected to the left and right channels of one of the inputs (**Input 1**, **Input 2**, or **Input 3**). In this case, the adjustment of the whole stereo pair is performed instead of the left and right signals separately. The **L/R Lock** check boxes located in the lower part of the input signal areas allow you to operate the inputs as three stereo pairs (Figure 14).

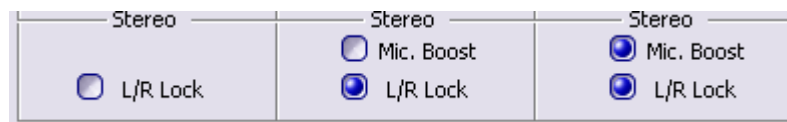

**Figure 14. The stereo mode check boxes and microphone boost.**

Each pair of the input signals can be used either as one stereo signal or as two independent mono signals. For example, if check the **L/R Lock** check box for inputs 1 and 2, the volume level, balance, and delay control parameters are common for both the inputs, and, accordingly, they are changed simultaneously.

When changing the volume level of a stereo pair, the volume level ratio of the left and right signals is kept. When the **L/R Lock** option is off, the parameters of the left and right mono signals are adjusted independently from each other. It is also possible to separately adjust the left and right signals of a stereo pair, join them into one stereo pair by checking the **L/R Lock** check box, and perform the adjustment of the stereo pair itself. At that, the ratio of the left and right signal parameters is kept (Figure 15).

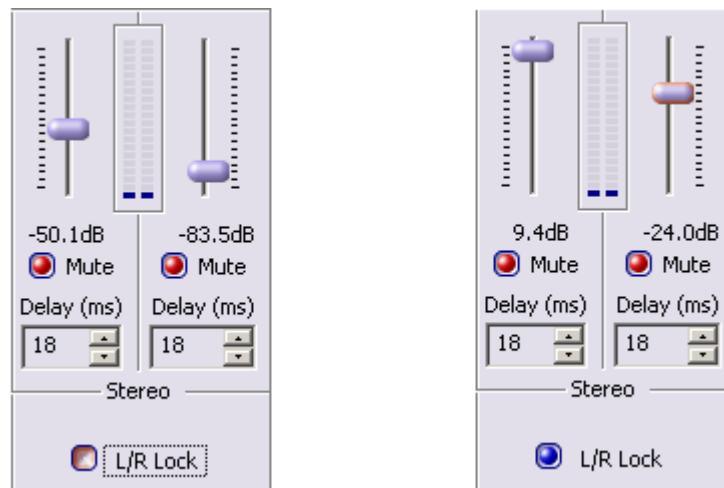

**Figure 15. Synchronous volume level change in the stereo mode.**

The **Mic. Boost** check box is provided for the input signals 3,4 and 5,6, (Figure 14). Checking the check box provides hardware amplification of an input signal by 20 dB and further working with the amplified signal. Such amplification is widely used, for example, when working with microphone. However, it is necessary to consider that the amplification is possible only for stereo pairs 2 and 3 and for the left and right signals simultaneously.

## 4 Controlling the PC Audio Devices

The *Sound Configure* application allows you to perform mixing sound signals from the external sources as well as signals from the system audio devices (the **CD Player**, a standard **Wave** device, the **SW Synth MIDI** synthesizer). Hereinafter, the signals from the listed system devices are referred to as the internal input signals. The sound subsystem of virtual studio *Focus* has a standard sound mixer controllable with the standard volume regulator.

This application allows you to redirect the internal input signals to different outputs.

The **PC Controls** area for controlling the internal input signals is located in the upper right part of the *Sound Configure* main window. The control elements of the area allow you to perform the balancing between the left and right channels, adjust the signal volume (from 0 dB to 96 dB), and disable a signal transfer to any output channel. There are three check boxes on the right of each channel. The check boxes allow you to redirect the internal input signals to any of the outputs. The upper check box corresponds to output 1, the middle – to output 2, and the lower – to output 3. The default position of the check boxes is shown in Figure 16.

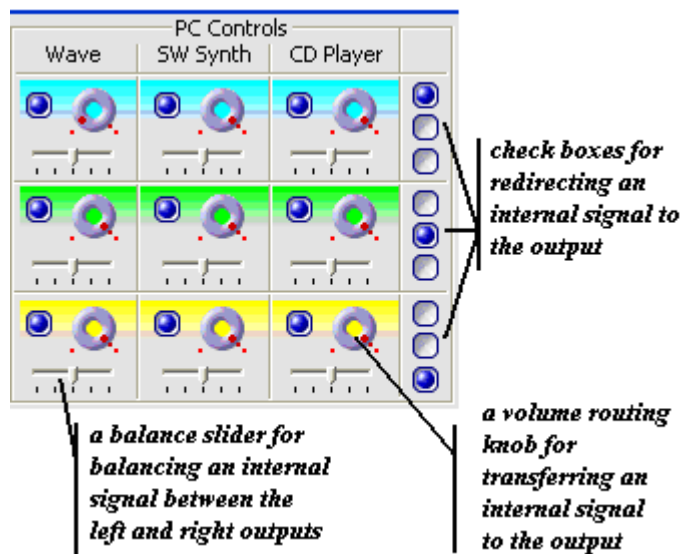

Figure 16. Mixing the internal input signals.

When changing the position of a routing knob, the tool tip shows the information of the output channel signal volume level and the number of the channel for which the signal is being adjusted (Figure 17).

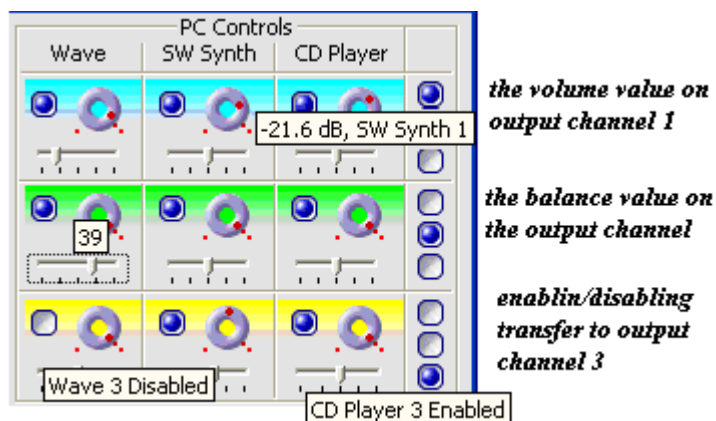



Figure 17. The tool tips.

 This application has the ability to change the zoom of the volume level scale for better usability of the volume slider, e.g., when working with loud signals (see Section 6).

## 5 Controlling the Output Signals

The **Outputs** area is located in the lower right part of the *Sound Configure* main window (Figure 2). All enabled input signals are mixed to the output channels.

The output signals are controlled as stereo signals: the adjustment is performed simultaneously for the left and right channels of a stereo signal. It is possible to set a volume level, change the balance for every output signal, or completely switch off a signal (Figure 18).

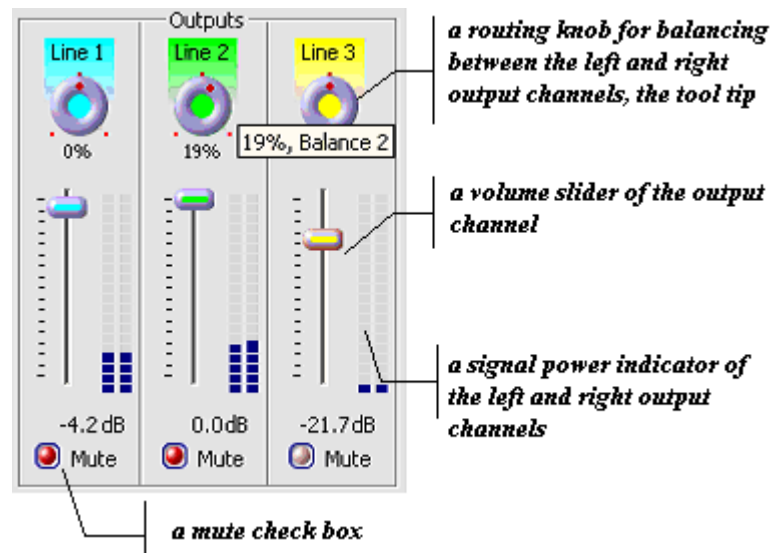



Figure 18. The controls of the output signals.

Each of the stereo outputs has the following control elements:

- a **Mute** check box for disabling the stereo output;
- a vertical volume slider;
- a routing knob for balancing between the left and right outputs.

 This application has the ability to change the zoom of the volume level scale for better usability of the volume slider, e.g., when working with loud signals (see Section 6).

## 6 Setting Application Parameters

The *Sound Configure* general settings area is located in the bottom part of the main window (Figure 14, Figure 19).

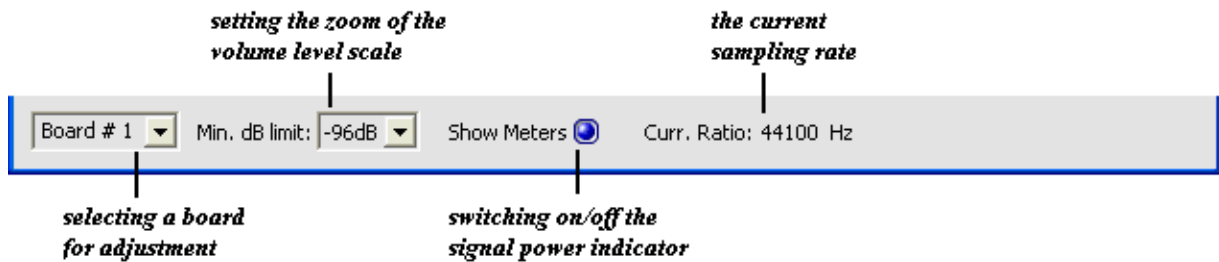

Figure 19. The *Sound Configure* general settings.

- The number of the *FD300* board used to work with audio is selected in the **Board #** drop-down list (Figure 20). To output audio via the selected board, one of its output audio devices must be selected in the operating system as the playback device (discussed in section 2.4 of *HotActionsLite\_User's Guide*).



Figure 20. Selecting an *FD300* board.

- The volume range for all inputs and outputs is set in the **Min. dB limit** drop-down list (Figure 21). The available volume range of the signal change in *Sound Configure* is from +12dB to -96dB for the external input channels, and from 0dB up to -96dB for the internal input and output channels. Often a finer volume adjustment is required when working, especially in the upper part of the volume range. For that, set a new lower limit for the volume scale in the **Min. dB limit:** drop-down list. **0 dB** corresponding to the maximum volume level is the topmost position of the slider.

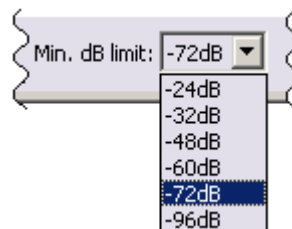

Figure 21. Selecting the zoom of the volume level scale.

Selecting a new lower limit of the volume scale affects all volume sliders located in the main window, as well as volume level indicators. The volume sliders change their positions according to the current volume and the new scale zoom (Figure 22).

When the signal volume level sinks below the current scale lower limit, the volume slider falls to the scale bottom (Figure 23). When trying to change the volume level of such a signal, it shifts abruptly to the current volume scale range, which can be accompanied by a «click» of the signal.

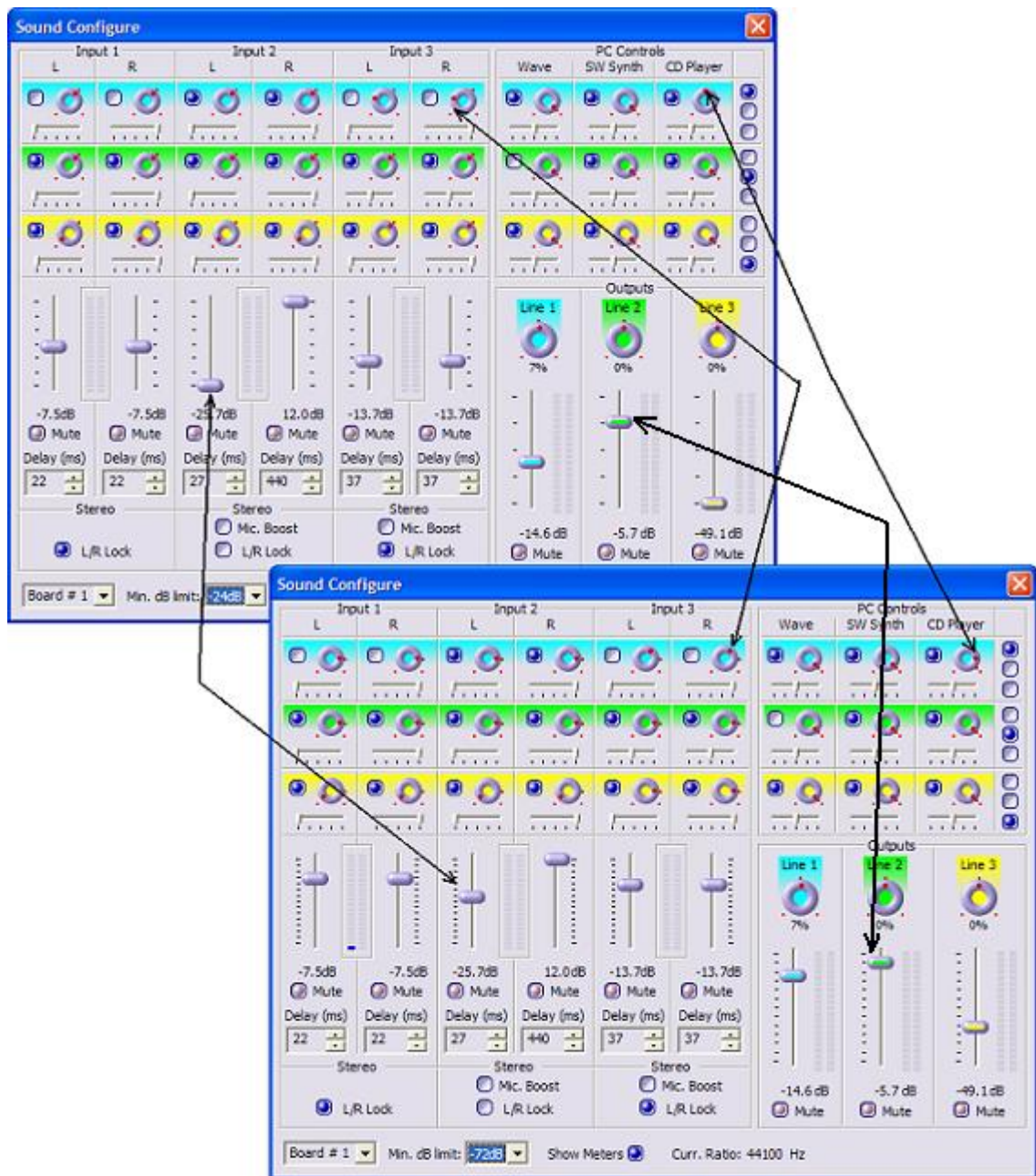

Figure 22. Changing the volume scale lower limit.

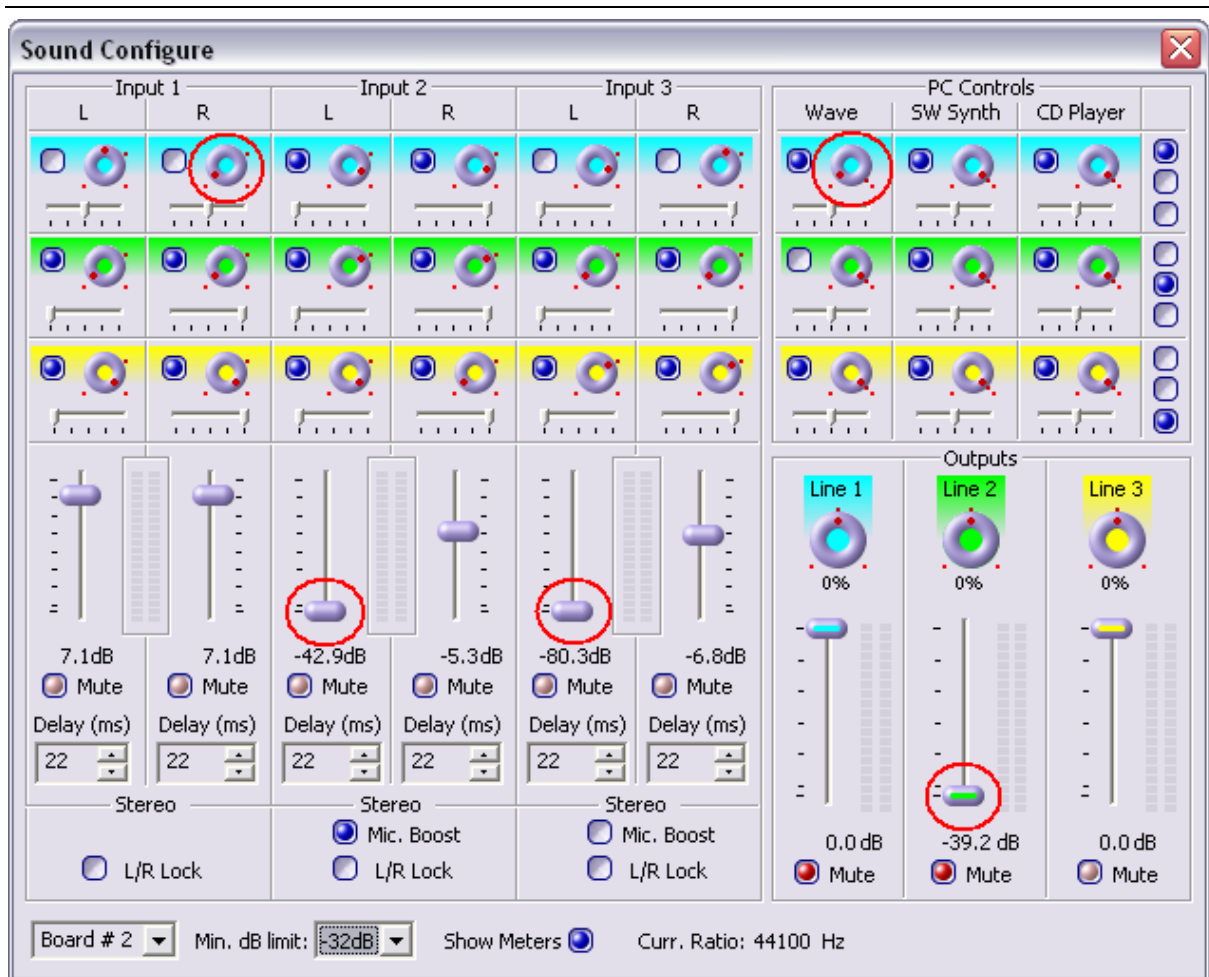

Figure 23. Changing the volume scale lower limit.

- Checking the **Show Meters** check box enables displaying the volume level indicator located alongside the volume level sliders on the inputs/outputs.
- The **Curr. Ratio** parameter displays the current audio sampling rate (in Hz). The sampling rate of the input and output signals is the same. This parameter can be modified in the *FD300Configuration* application (the *HotActionsLite* application must be closed before). The required sampling rate is selected in the **Internal processing sample** drop-down list in the **Sound** tab (for more detail, see the *Audio mixer sound settings* Section of the *FD 300 board settings User's Guide*).